

E K O

wall collection

by
gamlaa

INDEX

- 1.WALL ART
- 2.PIXEL ART
- 3.LOGO ART
- 4.ELEMTRY ART

Embellish a Workspace with Elegance, a geometric design with just a hint of color, and antiqued version with a subtle splatter of natural moss screens offer architectural and acoustic options for business spaces.

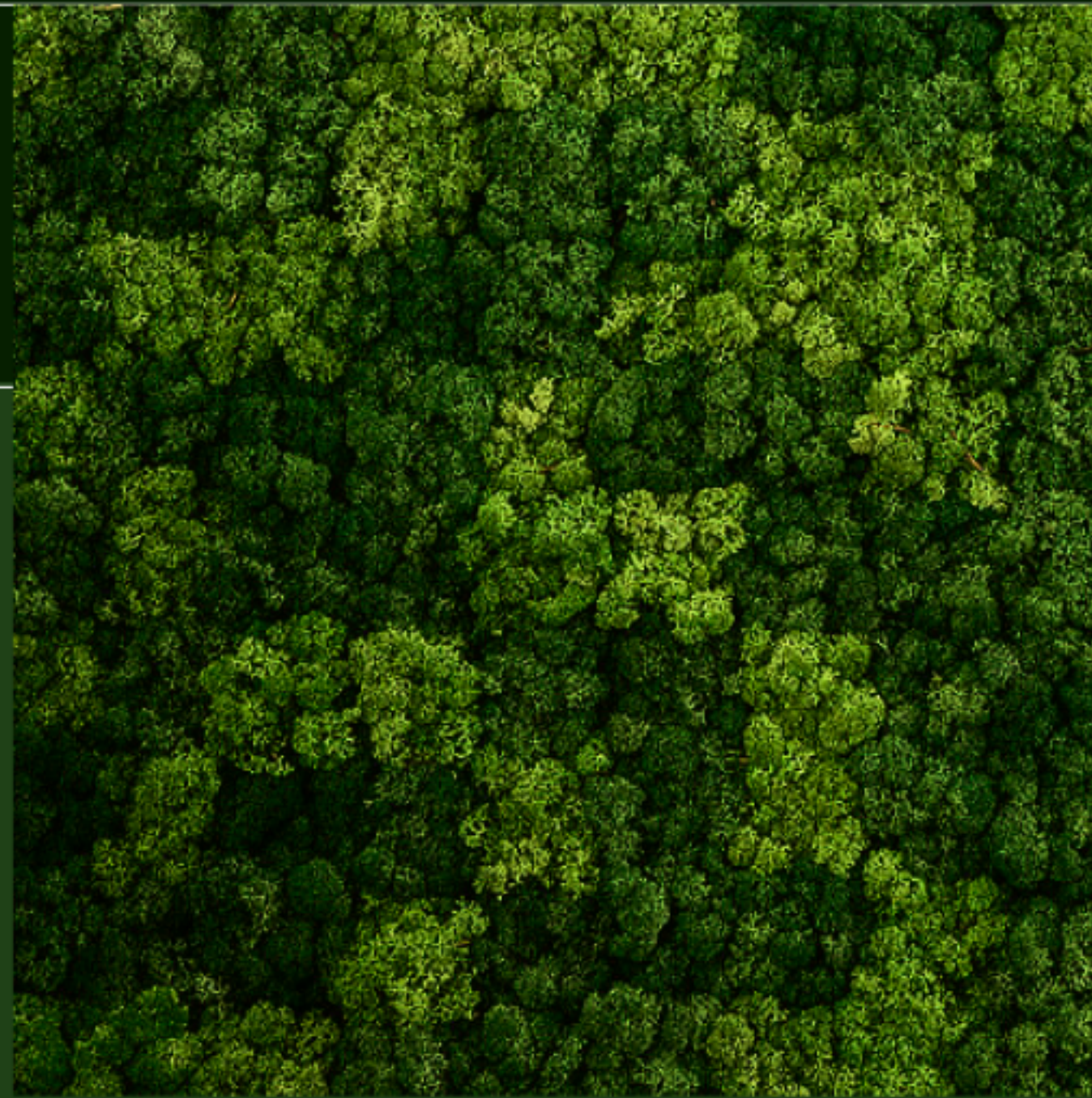

THE BENEFITS



Health

The preservation process involves solely unarmful & biobased materials, guaranteeing 100% biodegradable, hypoallergenic and non-toxic products.



Absorbing ambient noise from above



Maintenance

Preserved plants and mosses for indoor use only. That being said, they require no maintenance whatsoever: neither watering, pruning, nor even sunlight.



Nature connected to the ceiling



Durability

To achieve optimal durability, it is recommended to avoid exposure to direct sunlight and proximity to water or heat sources. As moss dries out when its environment does, it is strongly advised to avoid touching it. It will get back to the soft touch when humidity rises again and is a good humidity indicator.



Reducing Stress and promoting wellness

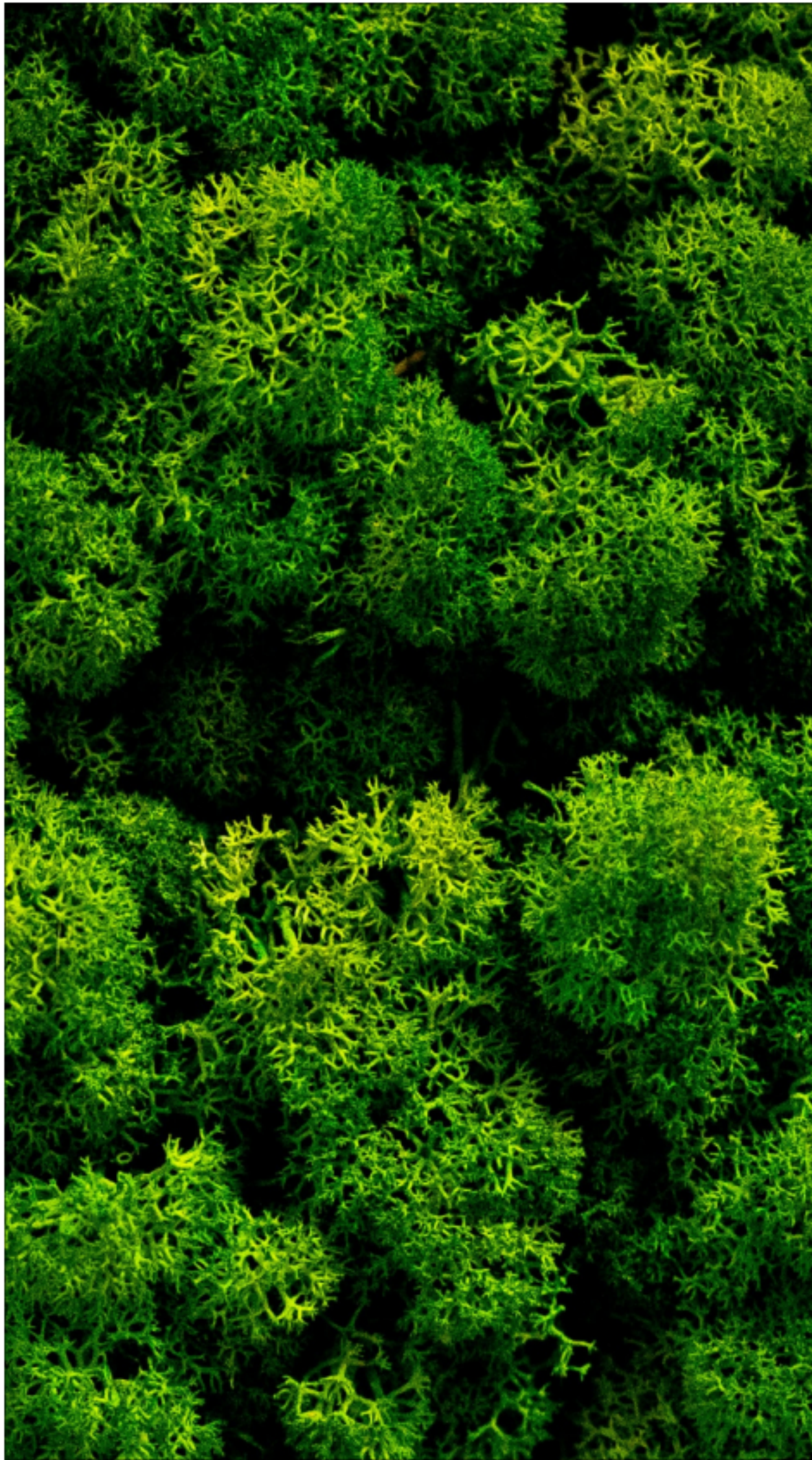

FLAT
MOSS



BALL
MOSS



LICHEN
MOSS

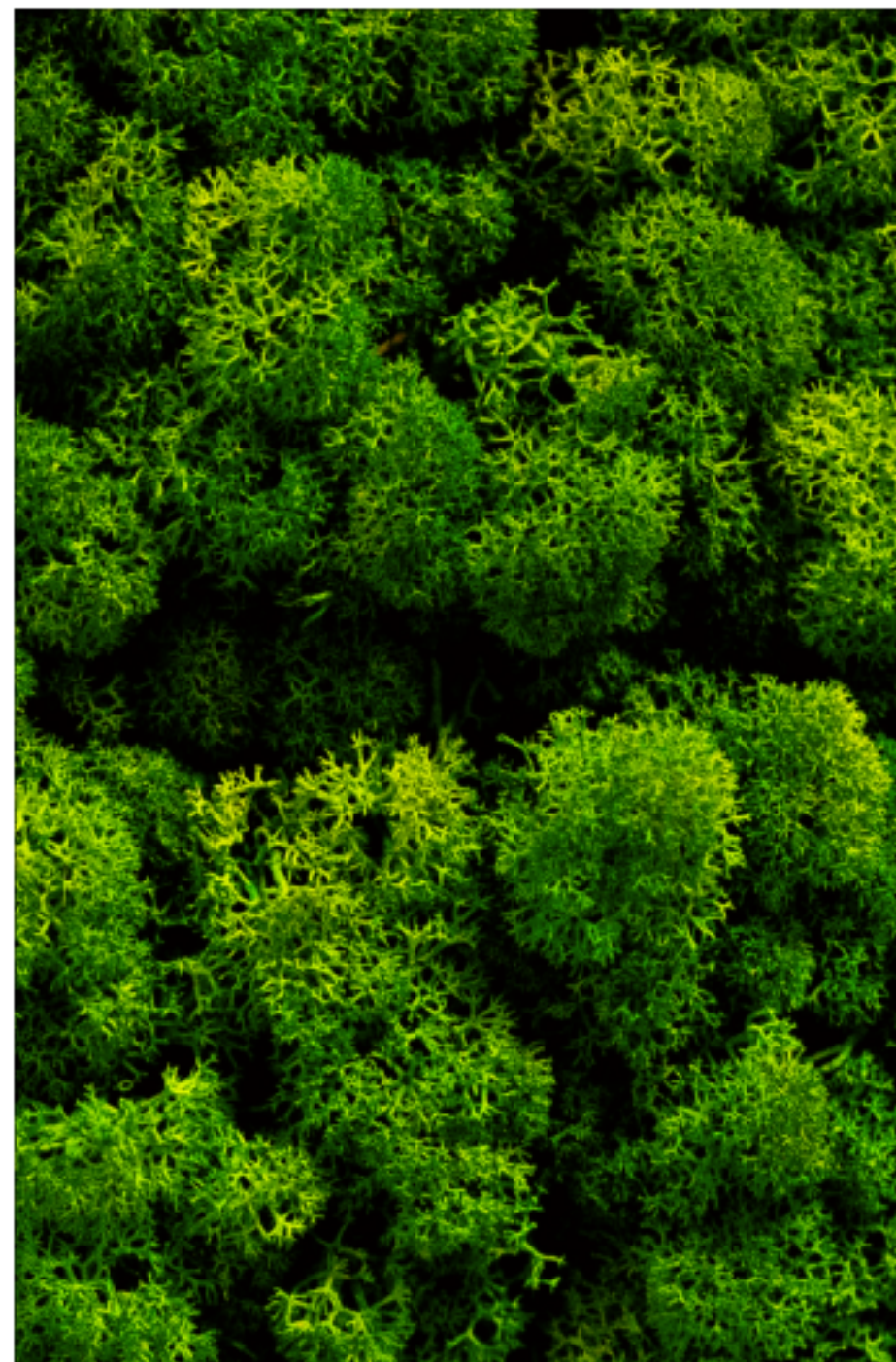

JUNGLE
MOSS

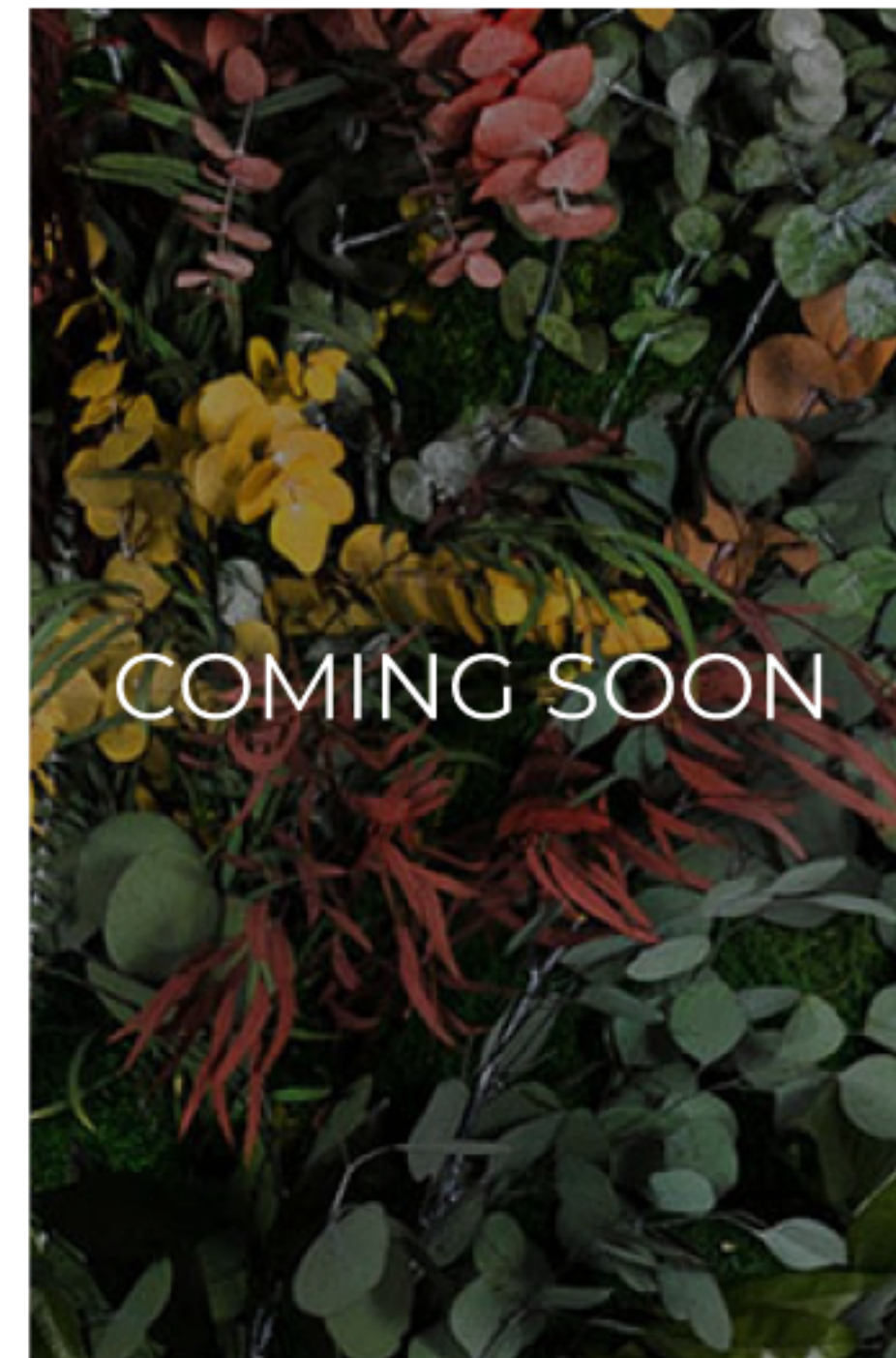

COMING SOON

WALL
ART





EKO | WALL

With various hues and moss varieties, a rich greenwall of moss that forms biomorphic to geometric designs based on the interior of the office area adds value to the surroundings.

MATERIAL

H.I.P.S. FRAME

DIMENSIONS

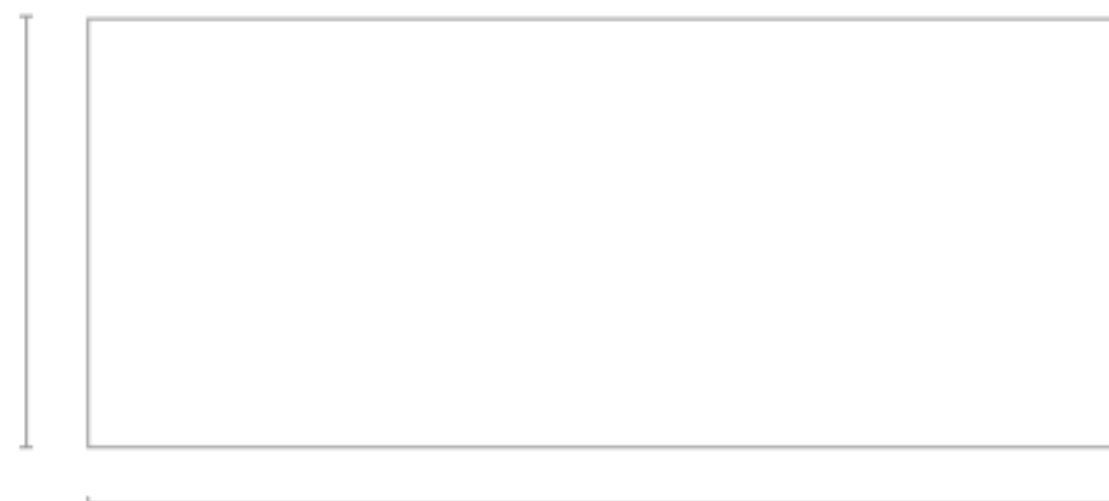

Custom sizes as per client

PIXEL
ART



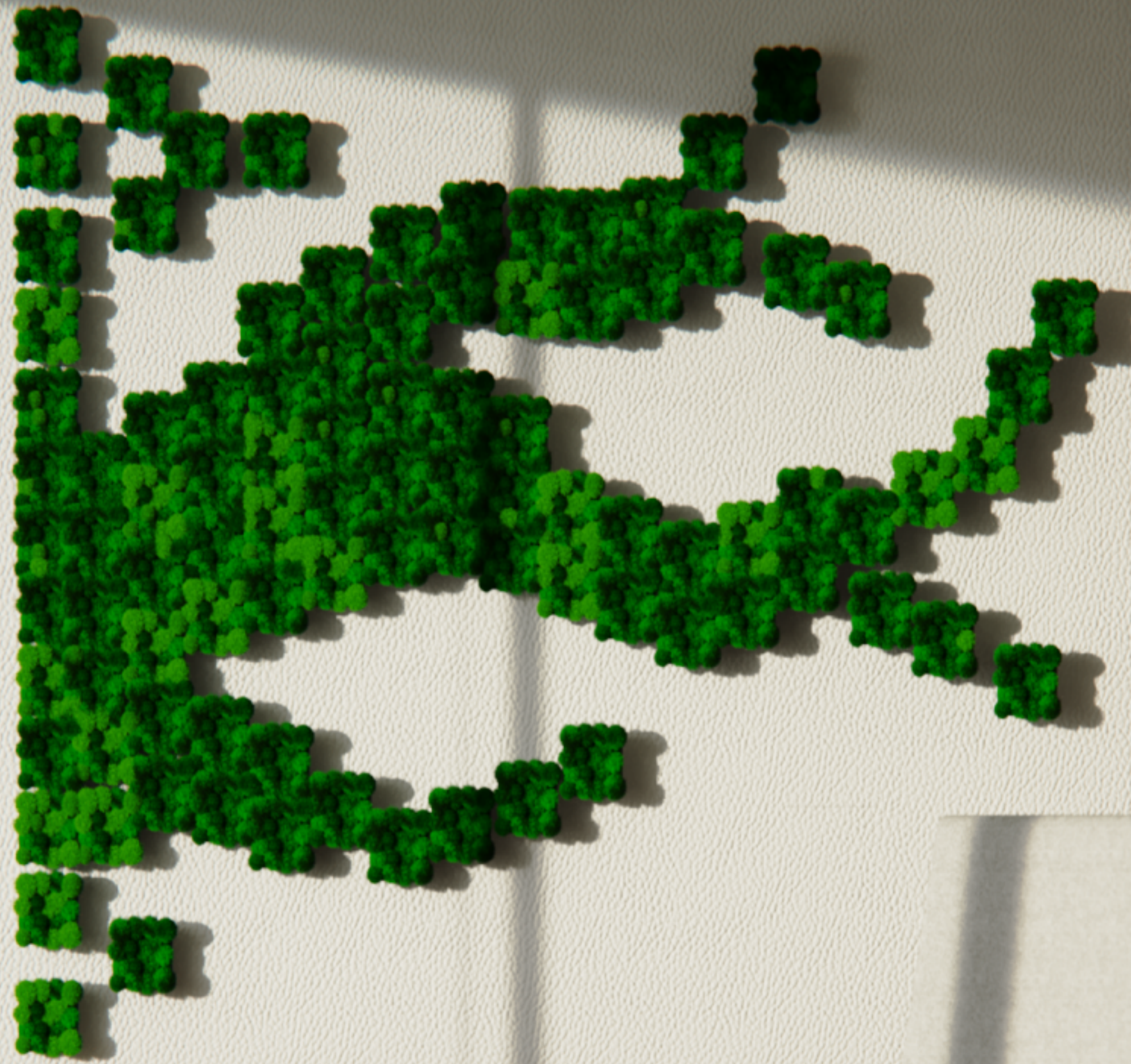

EKO | PIXEL

The little details are where you can get creative inspiration when you're focused on the structure and design. With our pixel-like modular design that generates the typical walls to visual, we set the benchmark for amazing decor, from moss to topology.

MATERIAL

H.I.P.S. FRAME

DIMENSIONS

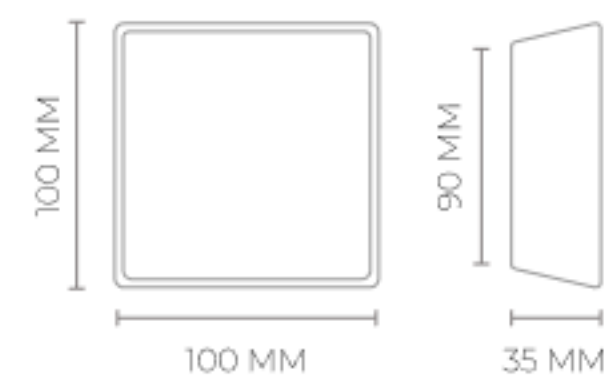

LOGO
ART





EKO | LOGO

The eko logo art is a fantastic way of creating bespoke moss wall branding and signage that satisfy the requirements of the workplace area. It reflects your sense of style, culture, and uniqueness.

MATERIAL

H.I.P.S. FRAME

DIMENSIONS



Custom sizes as per client

ELEMENTARY
ART





EKO | SQUARE

This simple form could be utilised to adorn the walls of an office. The elements that make up the shape of a square excite perception and thought. One of the earliest components of art and architecture, it has been used in many different cultures. Combining these ideas would result in a design statement.

MATERIAL

H.I.P.S. FRAME

DIMENSIONS

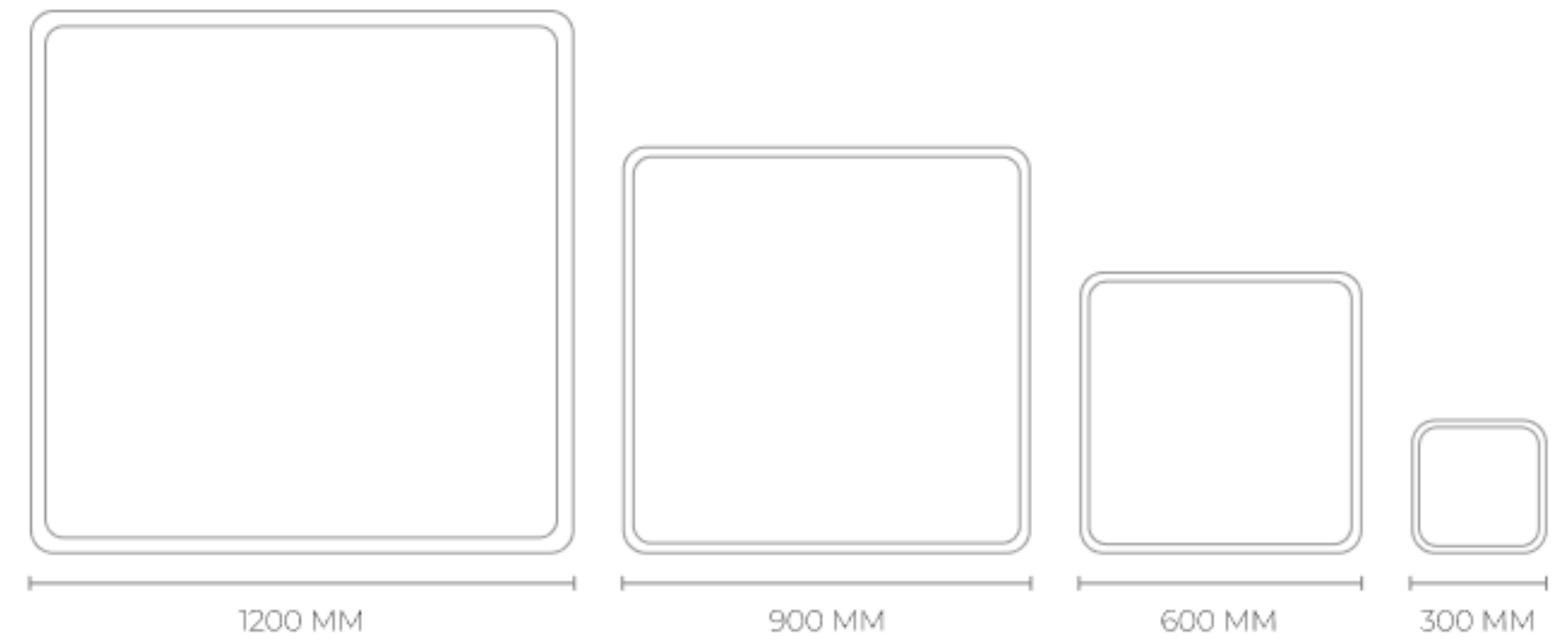



EKO | RECTANGLE

This simple form could be utilised to adorn the walls of an office. The elements that make up the shape of a rectangle excite perception and thought. One of the earliest components of art and architecture, it has been used in many different cultures. Combining these ideas would result in a design statement.

MATERIAL

H.I.P.S. FRAME

DIMENSIONS

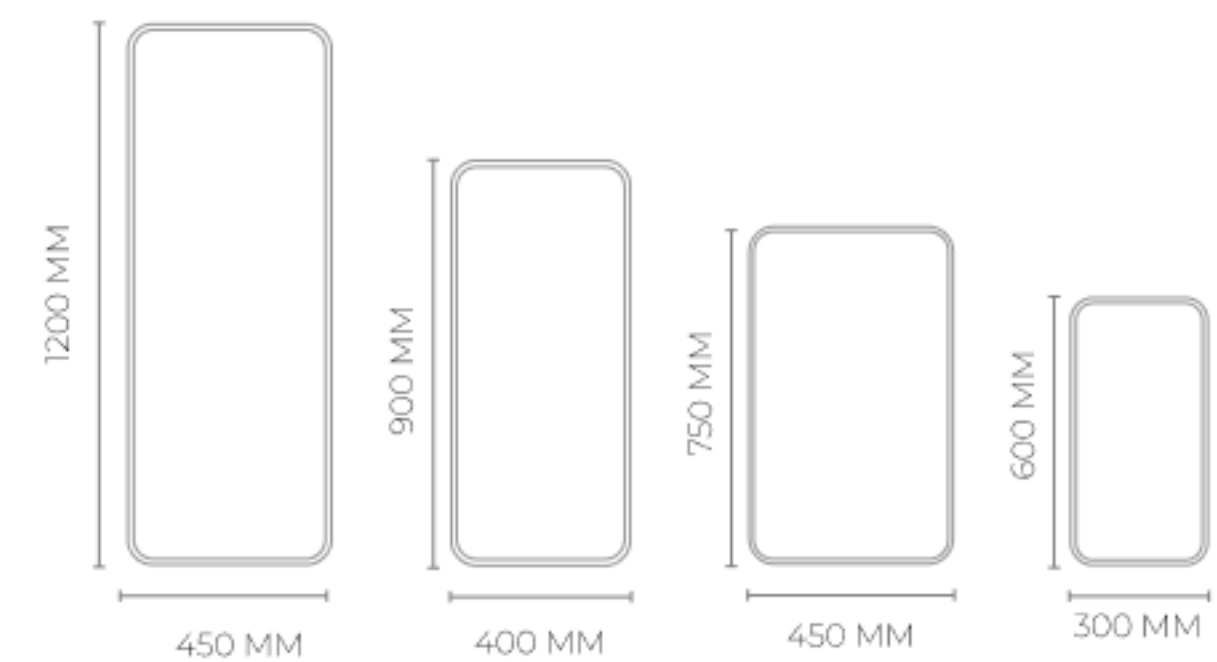

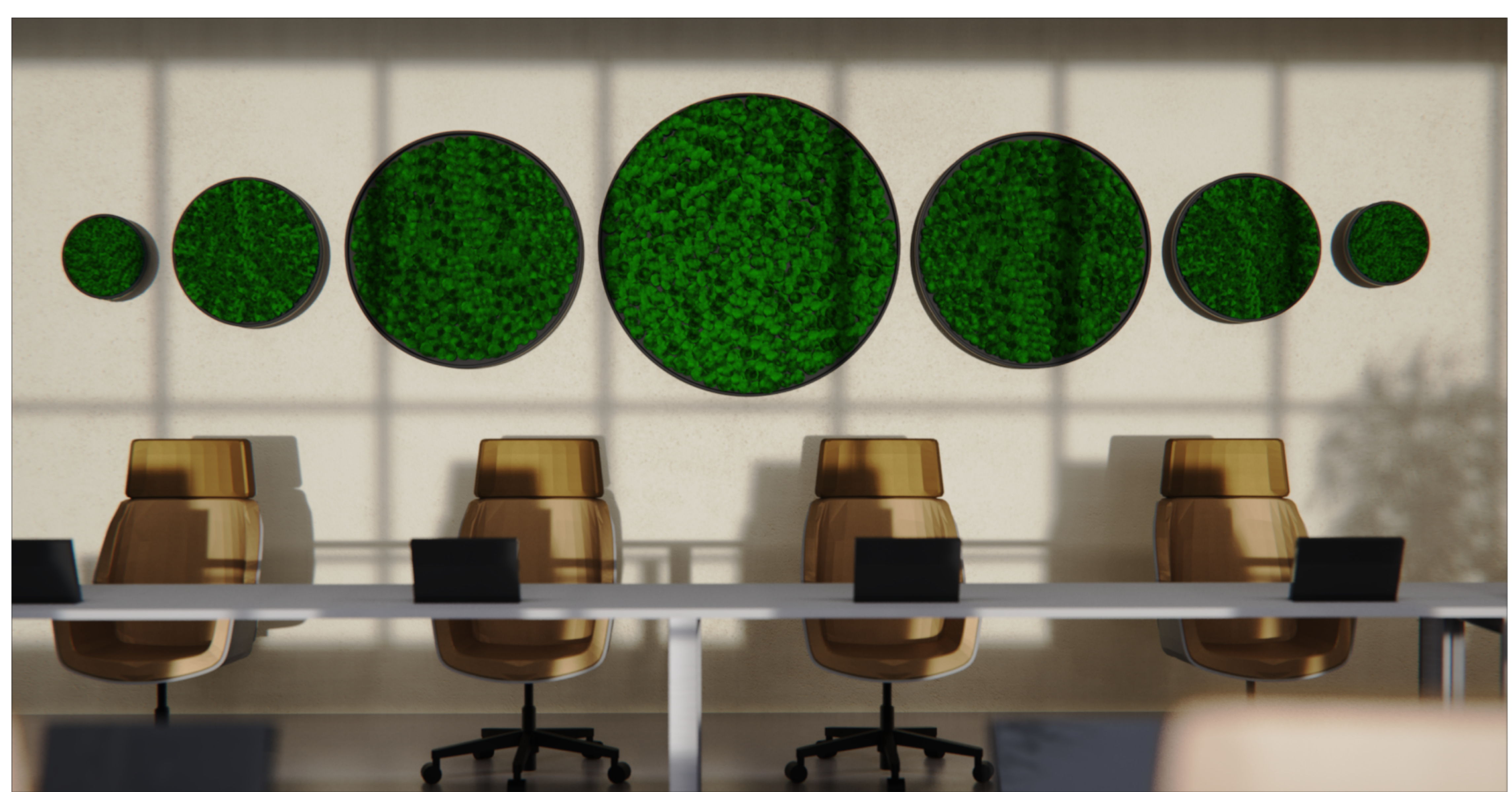

EKO | CIRCLE

This simple form could be utilised to adorn the walls of an office. The elements that make up the shape of a circle excite perception and thought. One of the earliest components of art and architecture, it has been used in many different cultures. Combining these ideas would result in a design statement.

MATERIAL

H.I.P.S. FRAME

DIMENSIONS

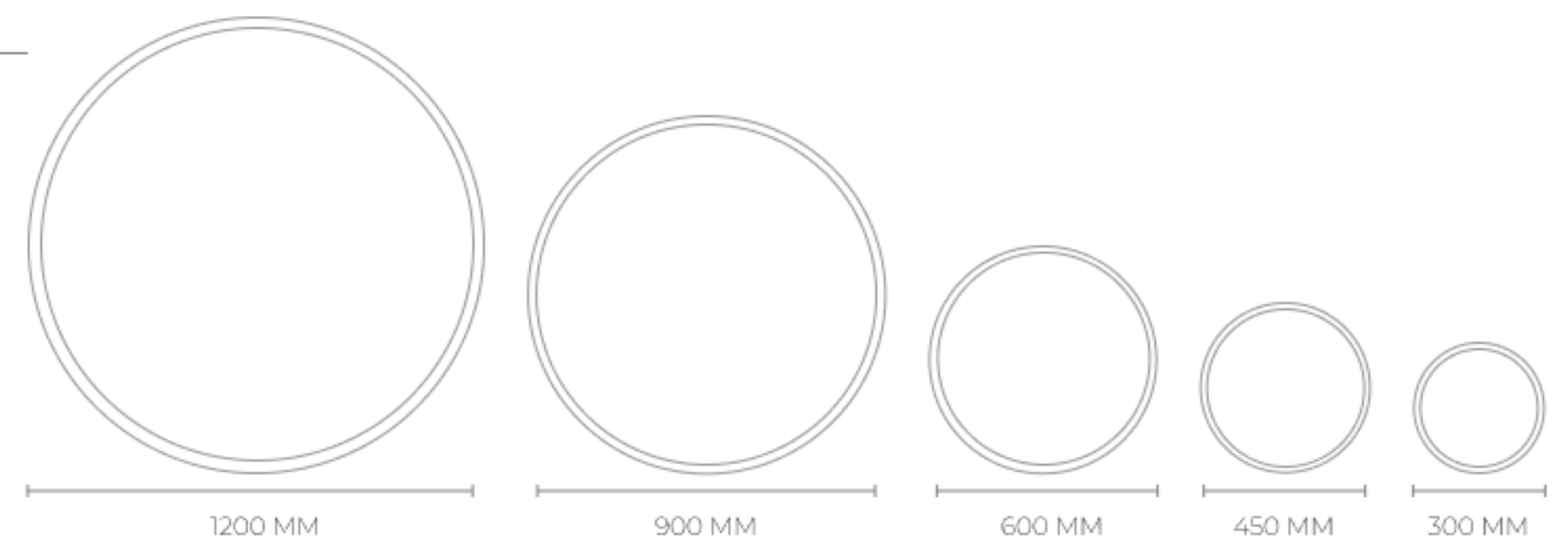



EKO | LEAF

This simple form could be utilised to adorn the walls of an office. The elements that make up the shape of a leaf excite perception and thought. One of the earliest components of art and architecture, it has been used in many different cultures. Combining these ideas would result in a design statement.

MATERIAL

H.I.P.S. FRAME

DIMENSIONS

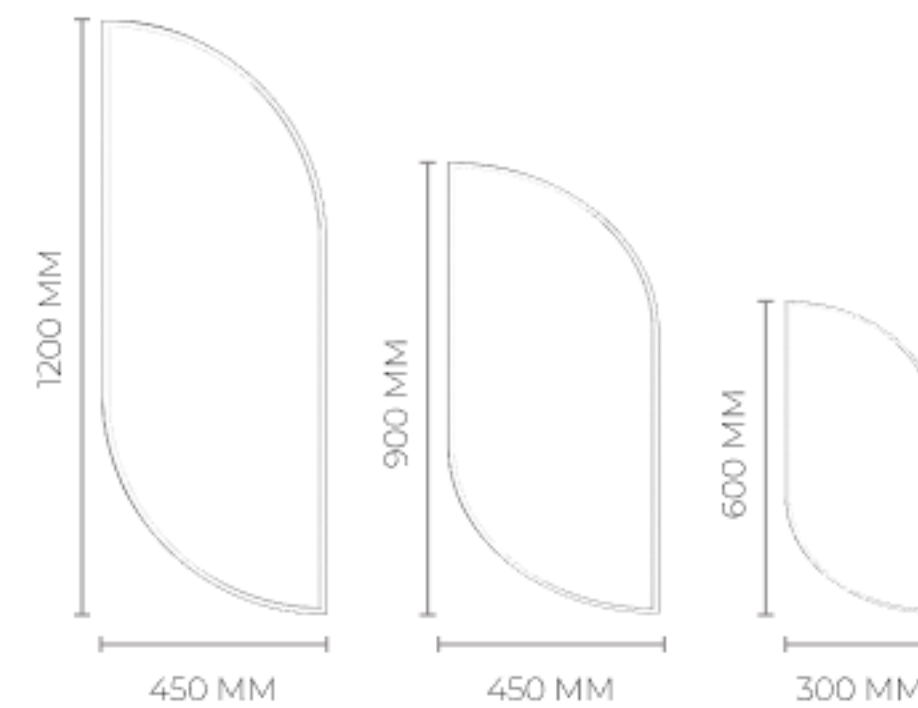

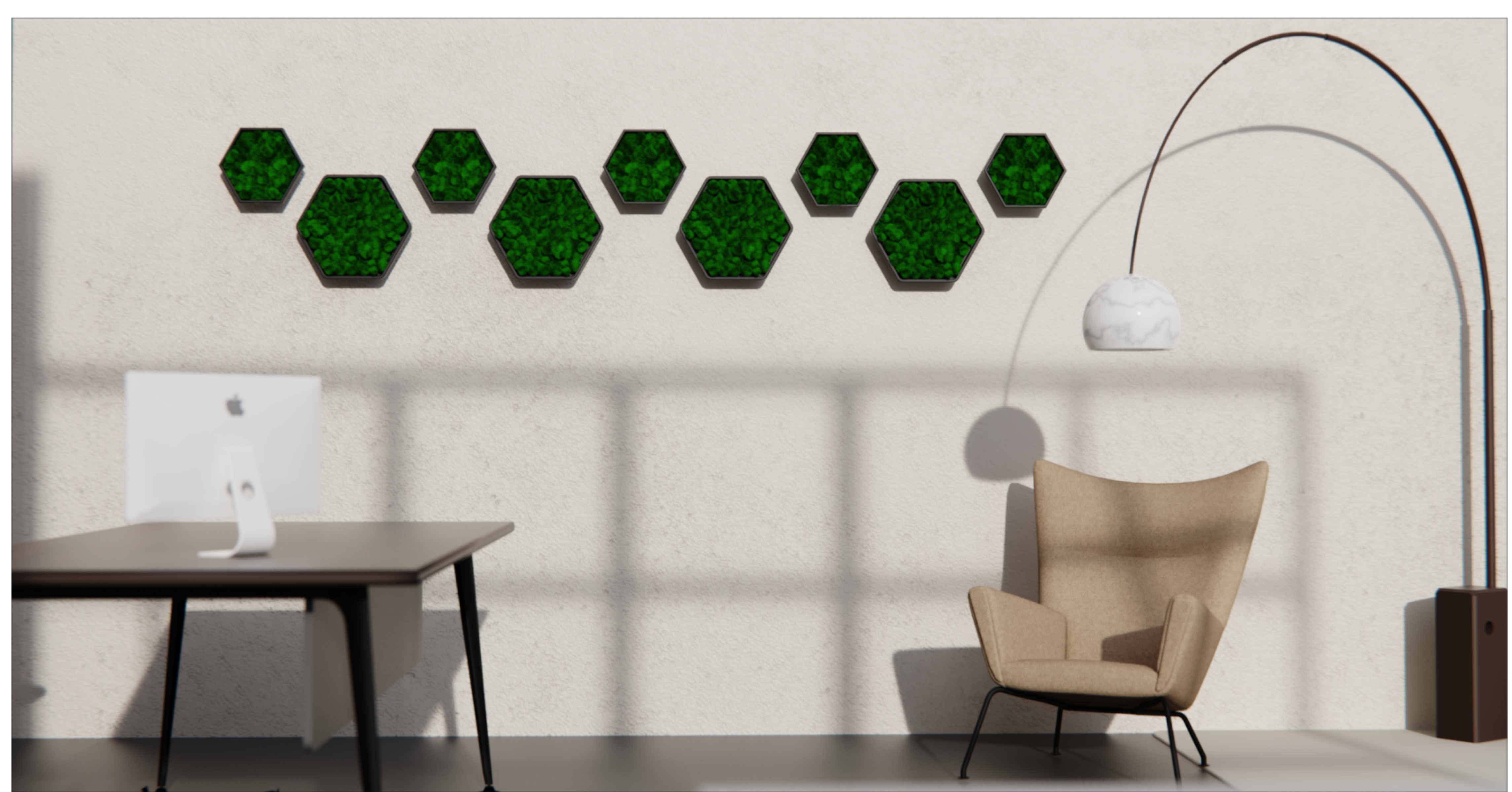

EKO | HEXAGON

This simple form could be utilised to adorn the walls of an office. The elements that make up the shape of a hexagon excite perception and thought. One of the earliest components of art and architecture, it has been used in many different cultures. Combining these ideas would result in a design statement.

MATERIAL

H.I.P.S. FRAME

DIMENSIONS

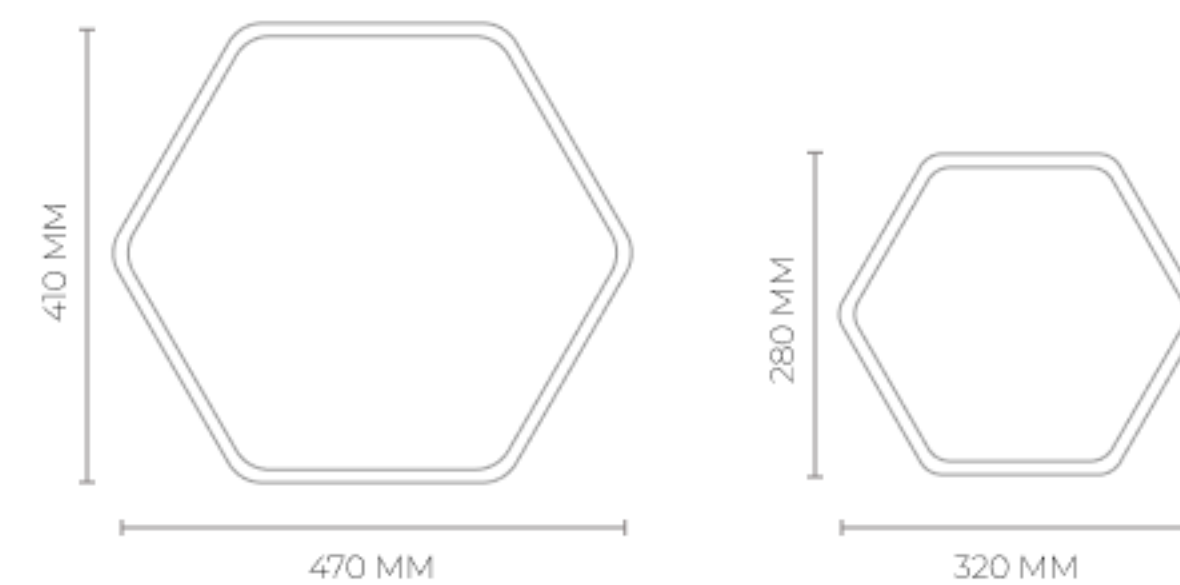

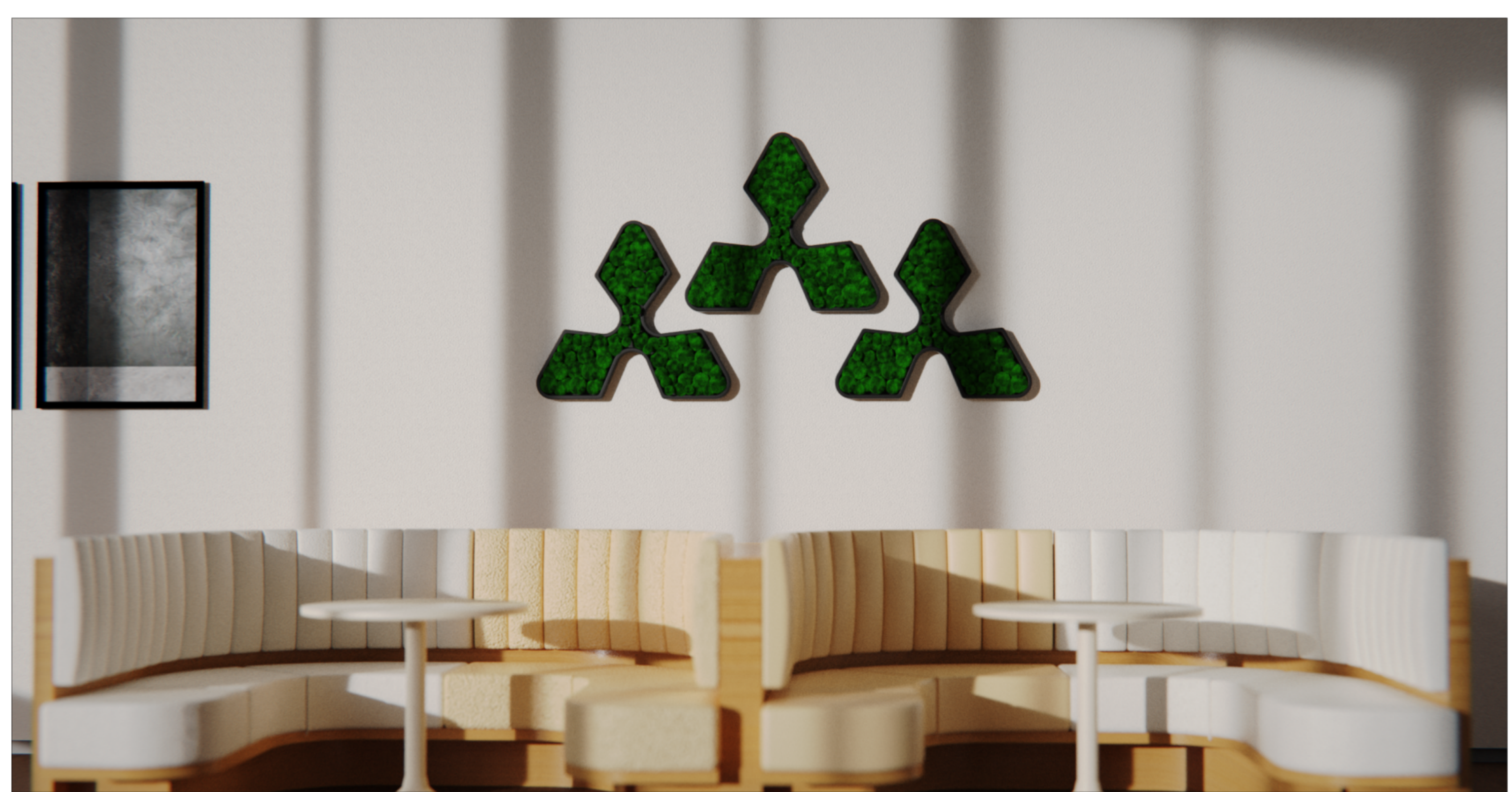

EKO | PETAL

This simple form could be utilised to adorn the walls of an office. The elements that make up the shape of a petal excite perception and thought. One of the earliest components of art and architecture, it has been used in many different cultures. Combining these ideas would result in a design statement.

MATERIAL

H.I.P.S. FRAME

DIMENSIONS

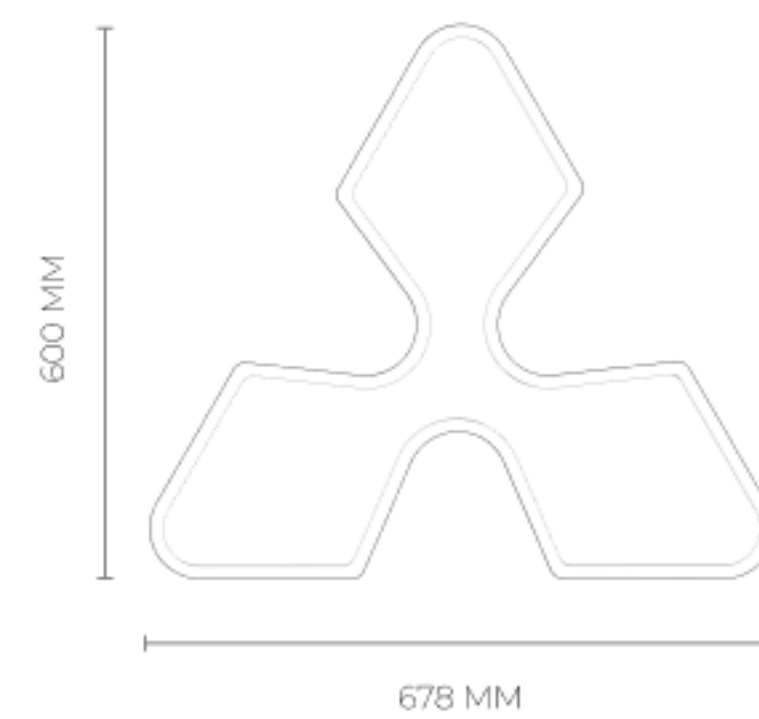

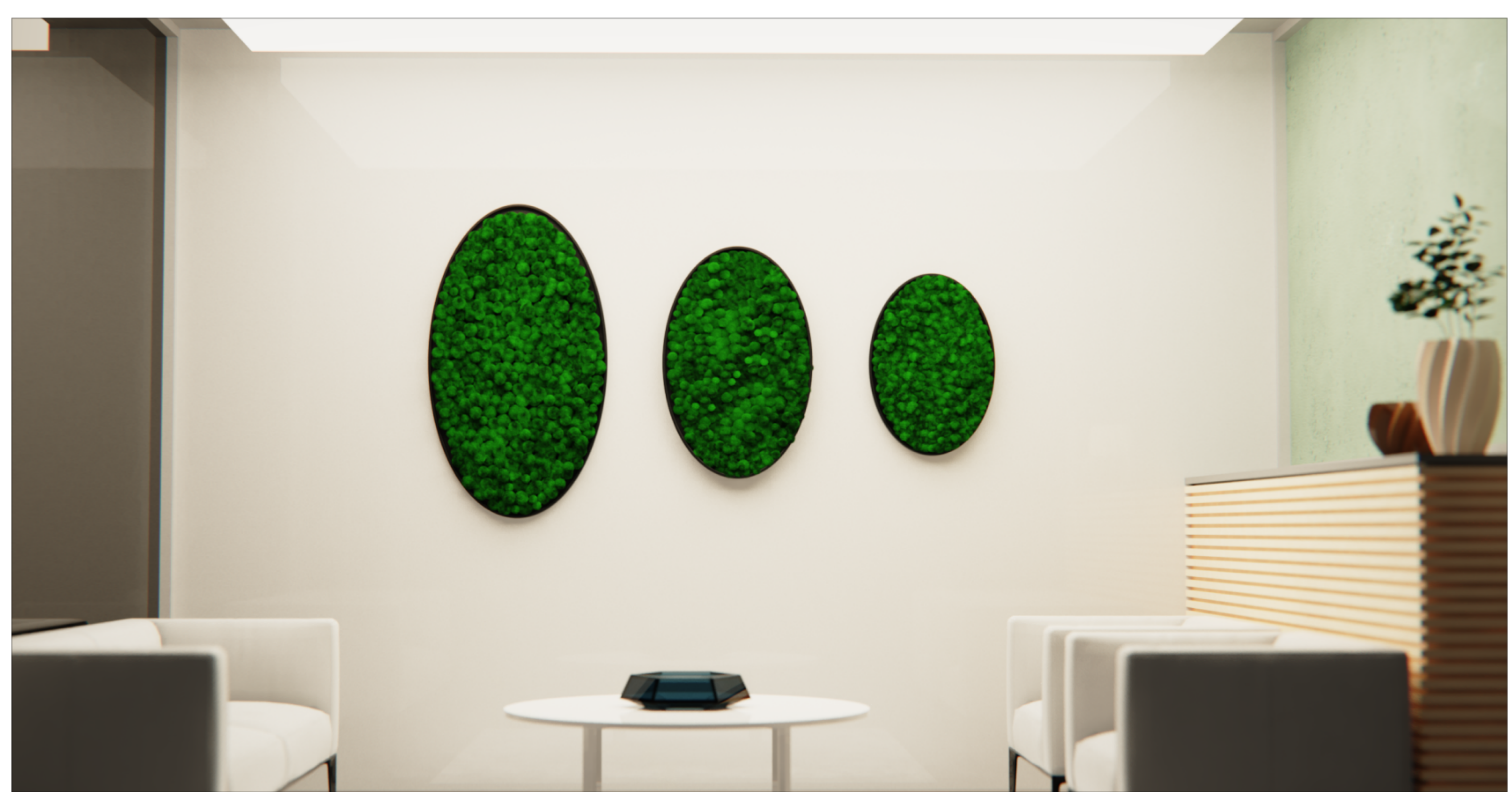

EKO | ELLIPSE

This simple form could be utilised to adorn the walls of an office. The elements that make up the shape of an ellipse excite perception and thought. One of the earliest components of art and architecture, it has been used in many different cultures. Combining these ideas would result in a design statement.

MATERIAL

H.I.P.S. FRAME

DIMENSIONS

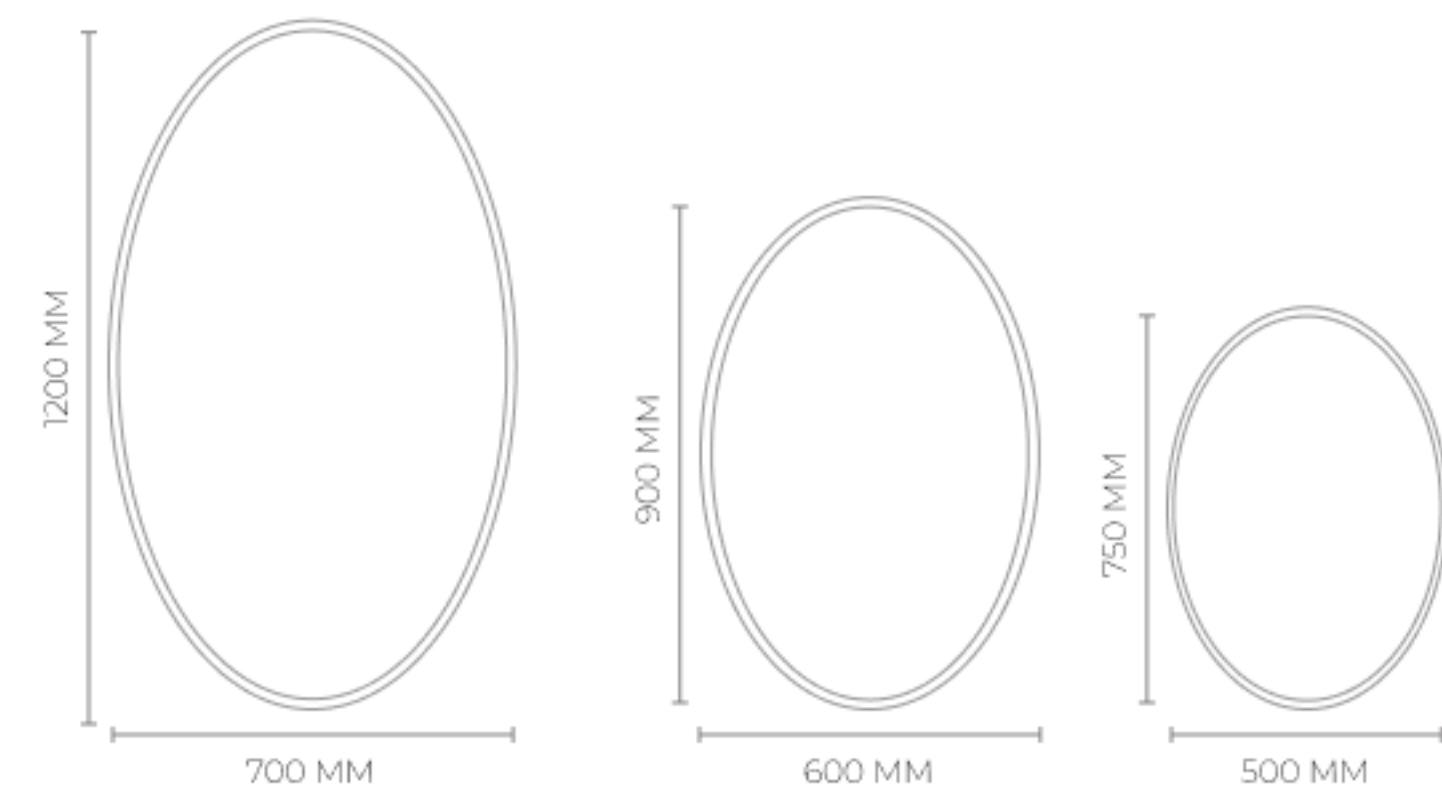

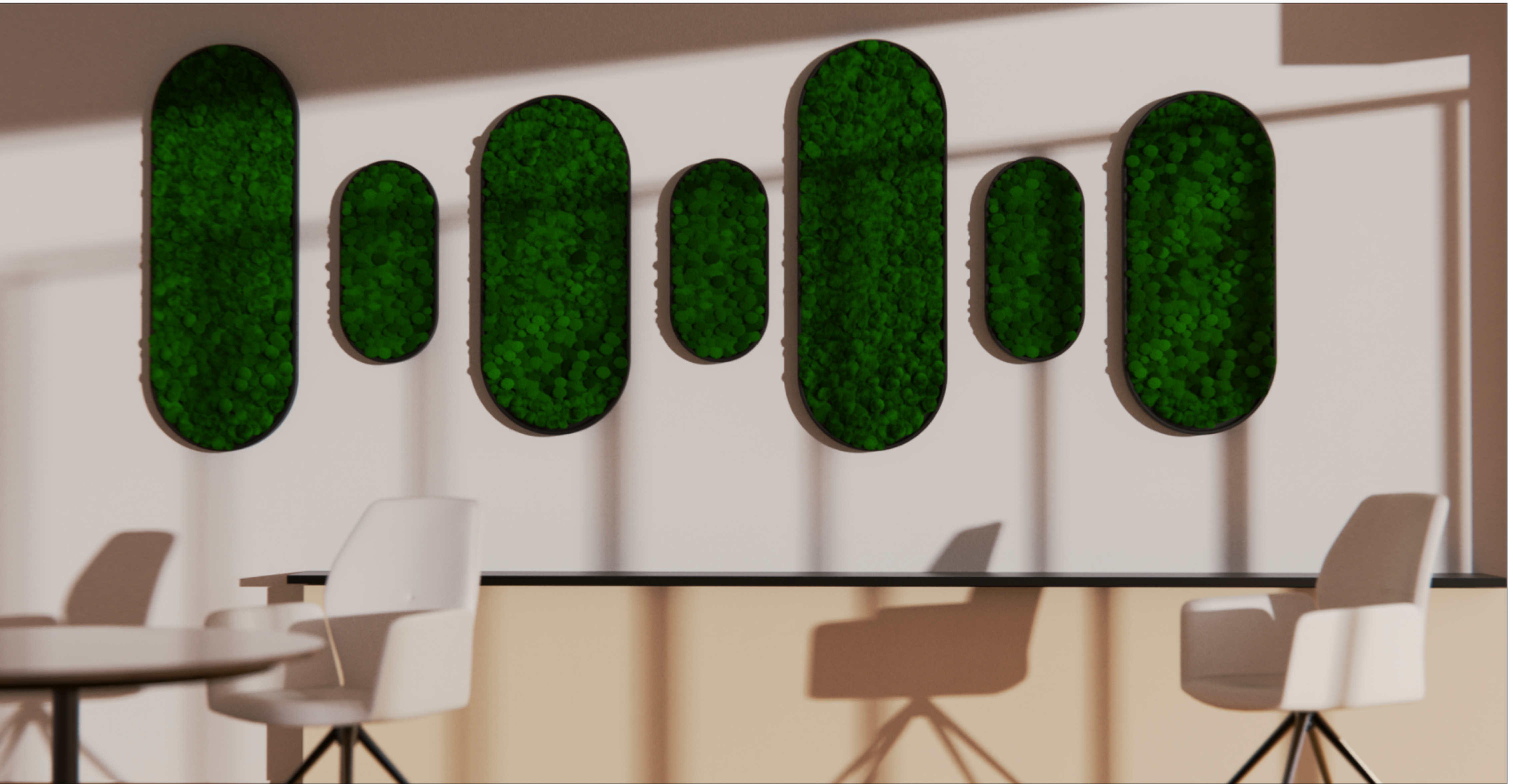

EKO | SLOT

This simple form could be utilised to adorn the walls of an office. The elements that make up the shape of a slot excite perception and thought. One of the earliest components of art and architecture, it has been used in many different cultures. Combining these ideas would result in a design statement.

MATERIAL

H.I.P.S. FRAME

DIMENSIONS

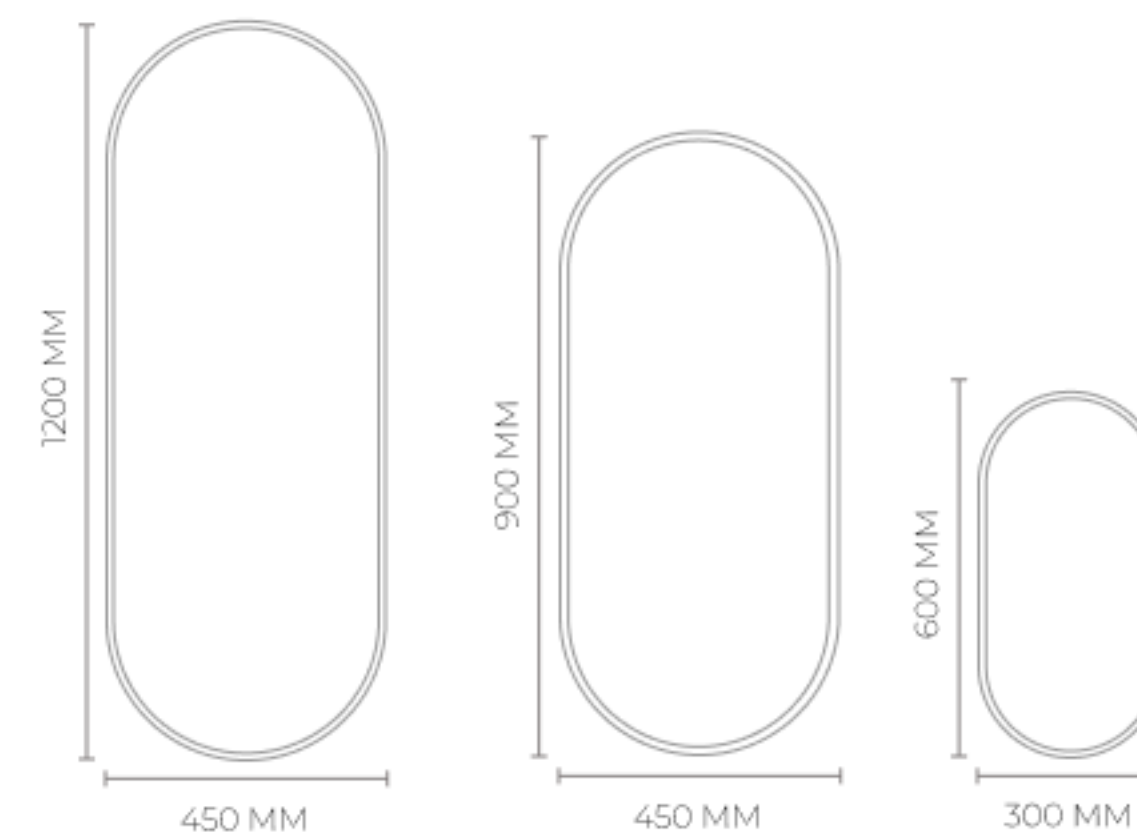

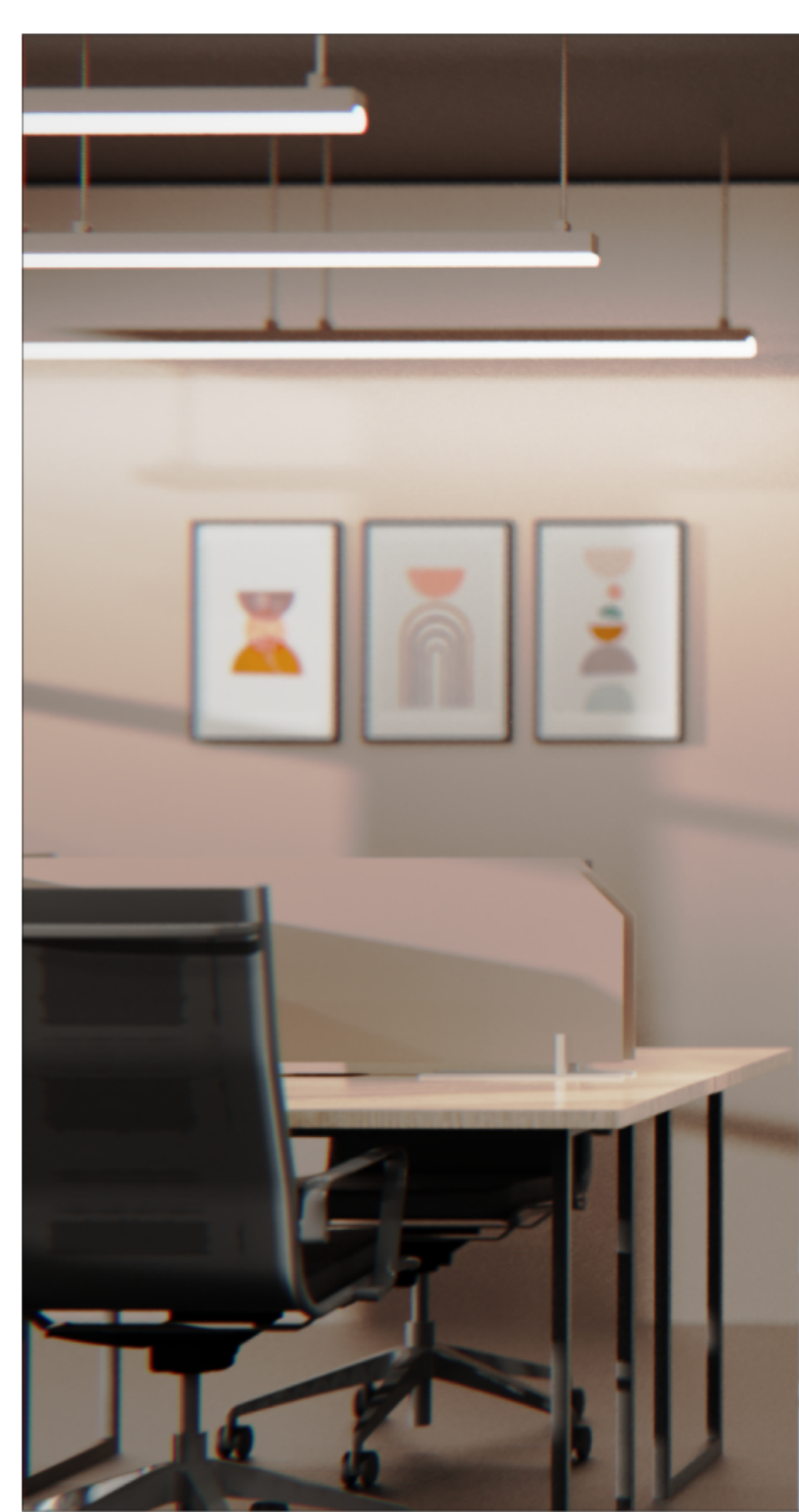

EKO | PEBBLE

This simple form could be utilised to adorn the walls of an office. The elements that make up the shape of a pebble excite perception and thought. One of the earliest components of art and architecture, it has been used in many different cultures. Combining these ideas would result in a design statement.

MATERIAL

H.I.P.S. FRAME

DIMENSIONS

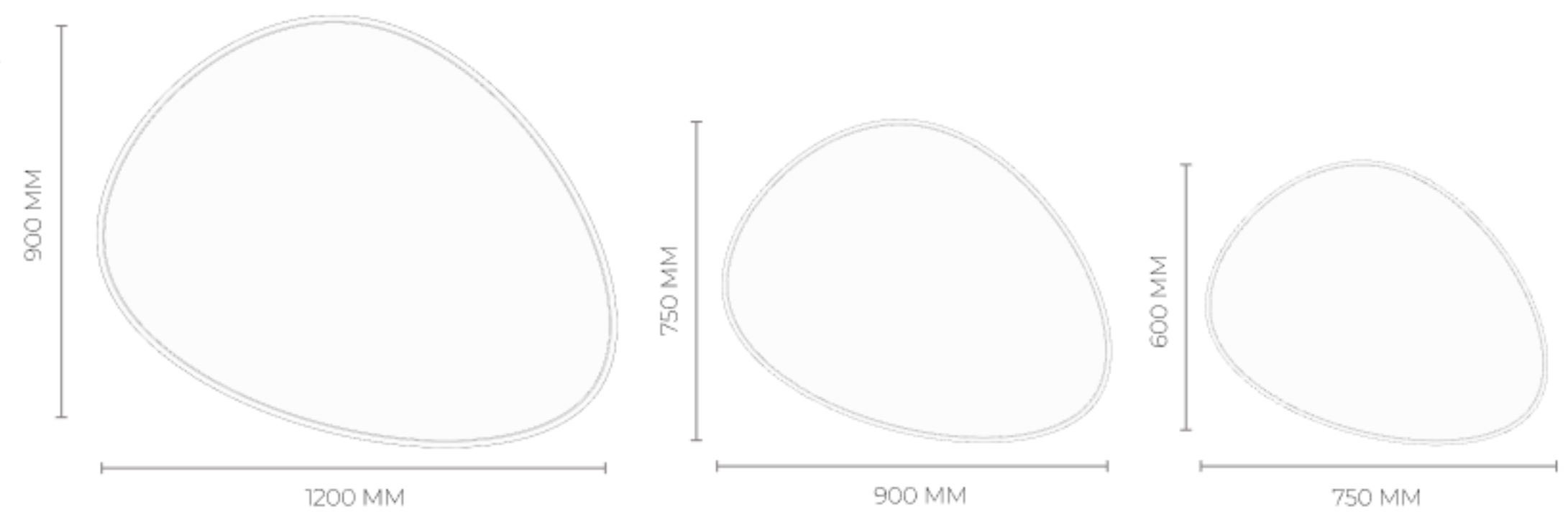

CUSTOMIZATION

MOSS
TYPES



FLAT

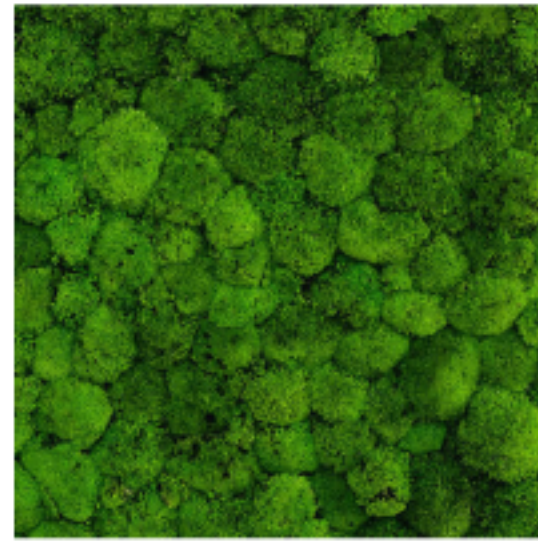

BALL

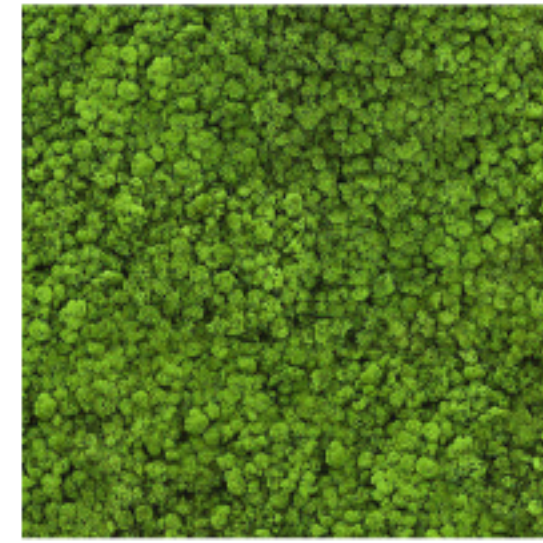

LICHEN



JUNGLE

MOSS
COLORS

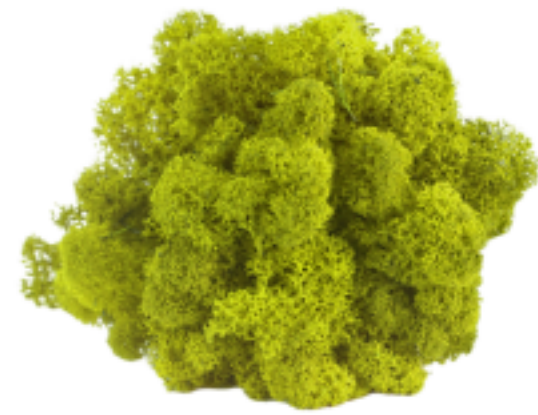

LIME GREEN



APPLE GREEN



DARK GREEN



OLIVE GREEN

EKO WALL COLLECTION

Gamlaa Bioscapes Pvt. Ltd.

Unit No 201, Jyothi Flora, Plot No 241, Survey No. 48/
AA, Kavuri Hills, Serilingampally, Ranga Reddy
District, Telangana - 500081

Office: +91 40 40202777 | www.gamlaa.com

Hyderabad | Bengaluru | Chennai | Pune | Mumbai | Ahmedabad | Delhi NCR

